

version .0

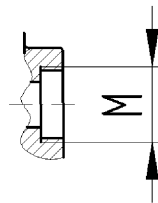
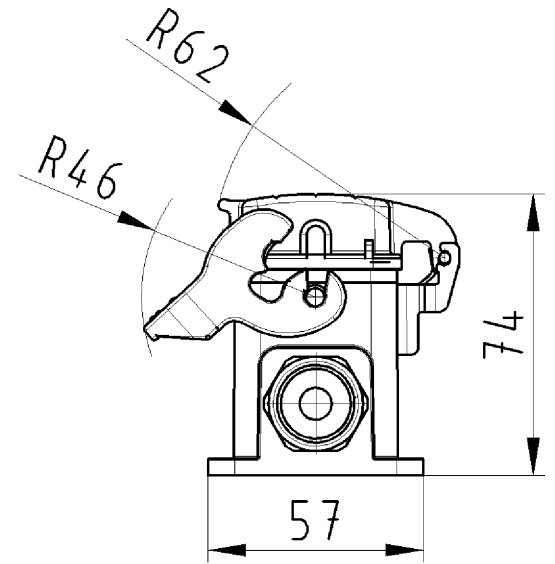
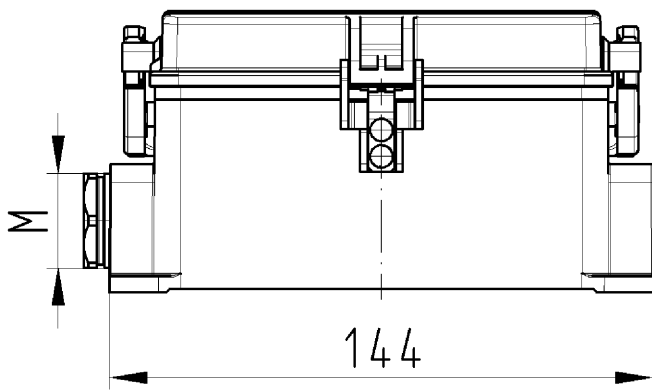

version .1

Gehäuseunterteil
71.342.2435.0

Zeichnungsnummer
71.342.2435.010W
Gehäuseunterteil

23.11.2007
Schreiber Patrick
M 1:2